

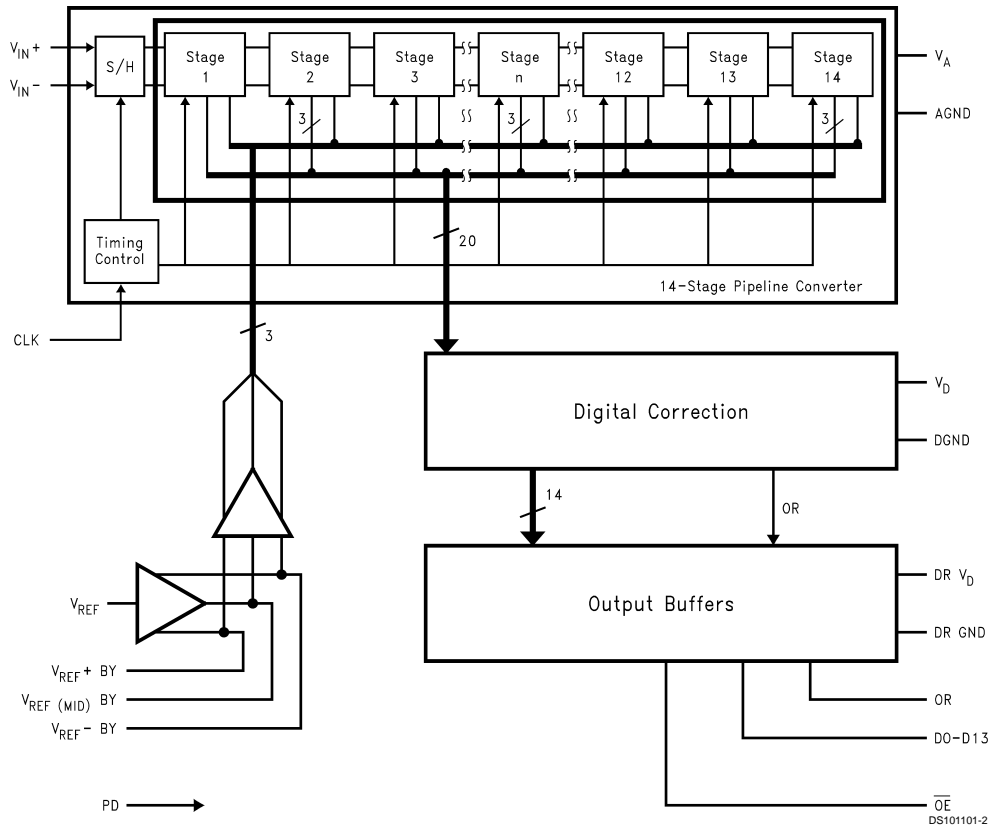

### Ordering Information

Industrial Temperature Range ( $-40^{\circ}\text{C} \leq T_A \leq +85^{\circ}\text{C}$ )	NS Package
ADC14071CIVBH	VBH48A 48-Pin Thin Quad Flatpak
ADC14071EVAL	Evaluation System

### Block Diagram



### Pin Descriptions and Equivalent Circuits

Pin No.	Symbol	Equivalent Circuit	Description
<b>ANALOG I/O</b>			
2	$V_{IN+}$		Non-Inverting analog signal input. With a 2.0V reference voltage the input signal voltage range is from 0V to 2.0V.
3	$V_{IN-}$		Inverting analog signal input. With a 2.0V reference voltage the input signal voltage range is from 0V to 2.0V. This pin may be connected to a voltage of 1/2 the reference voltage for single-ended operation, but a balanced input signal is required for best performance.
43	$V_{REF IN}$		Positive reference input. This pin should be bypassed to AGND with a 0.1 $\mu\text{F}$ monolithic capacitor. $V_{REF}$ is 2.0V nominal and should be in the range of 1.0V to 2.7V.

Pin Descriptions and Equivalent Circuits (Continued)			
Pin No.	Symbol	Equivalent Circuit	Description
<b>ANALOG I/O</b>			
47	$V_{REF+} BY$		<p>These pins are high impedance reference bypass pins only. Connect a 0.1<math>\mu</math>F capacitor from each of these pins the AGND. DO NOT connect anything else to these pins.</p>
1	$V_{REF (MID)} BY$		
45	$V_{REF-} BY$		
<b>DIGITAL I/O</b>			
11	CLOCK		<p>Digital clock input. The range of frequencies for this input is 25 kHz to 8 MHz (typical) with guaranteed performance at 7 MHz. The input is sampled on the rising edge of this input.</p>
12	$\overline{OE}$		<p><math>\overline{OE}</math> is the output enable pin that, when low, enables the TRI-STATE<sup>®</sup> data output pins. When this pin is high, the outputs are in a high impedance state.</p>
10	PD		<p>PD is the Power Down input pin. When high, this input puts the converter into the power down mode. When this pin is low, the converter is in the active mode.</p>
36	OR		<p>Out of Range pin. A high at this output pin indicates that the input voltage is either above the reference voltage or is below ground. When this pin is high, the digital output pins will indicate a full scale for input voltages above the reference voltage, or will indicate a zero scale for input voltages below zero scale.</p>
19-23, 25-29, 32-35	D0–D13		<p>Digital data output pins that make up the 14-bit conversion results. D0 is the LSB, while D13 is the MSB of the straight binary output word.</p>
<b>ANALOG POWER</b>			
5, 6, 7, 13, 41	$V_A$		<p>Positive analog supply pins. These pins should be connected to a clean, quiet +5V voltage source and bypassed to AGND with 0.1 <math>\mu</math>F monolithic capacitors located within 1 cm of these power pins, and by a 10 <math>\mu</math>F capacitor.</p>
4, 8, 9, 14, 15, 42	AGND		<p>The ground return for the analog supply. AGND and DGND should be connected together directly beneath the ADC14071 package. See Section 5 (Layout and Grounding) for more details.</p>

<b>Pin Descriptions and Equivalent Circuits</b> (Continued)			
<b>Pin No.</b>	<b>Symbol</b>	<b>Equivalent Circuit</b>	<b>Description</b>
<b>DIGITAL POWER</b>			
17	$V_D$		Positive digital supply pin. This pin should be connected to the same clean, quiet +5V source as is $V_A$ and bypassed to DGND with a 0.1 $\mu$ F monolithic capacitor in parallel with a 10 $\mu$ F capacitor, both located within 1 cm of the power pin.
16	DGND		The ground return for the digital supply. AGND and DGND should be connected together directly beneath the ADC14071 package. See Section 5 (Layout and Grounding) for more details.
31	DR $V_D$		Positive digital supply pin for the ADC14071's output drivers. This pin should be connected to a voltage source of +3 to +5V and bypassed to DR GND with a 0.1 $\mu$ F monolithic capacitor. If the supply for this pin is different from the supply used for $V_A$ and $V_D$ , it should also be bypassed with a 10 $\mu$ F tantalum capacitor and never exceed the voltage on $V_D$ . All bypass capacitors should be located within 1 cm of the supply pin.
24, 30, 37	DR GND		The ground return for the digital supply for the ADC14071's output drivers. These pins should be connected to the system digital ground, but not be connected in close proximity to the ADC14071's DGND or AGND pins. See Section 5 (Layout and Grounding) for more details.
<b>NC</b>			
18, 38, 39, 40, 44, 46, 48	NC		All pins marked NC (no connect) should not be connected to any potential (or to ground). Allow these pins to float.

### Absolute Maximum Ratings (Notes 1, 2)

If Military/Aerospace specified devices are required, please contact the National Semiconductor Sales Office/Distributors for availability and specifications.

Supply Voltage ( $V^+ = V_A = V_D = DR V_D$ )	6.0V
$V_A - DR V_D, V_D - DR V_D$	$\geq 0V$
Voltage on Any I/O Pin	-0.5V to $V^+ + 0.5V$
Input Current at Pins 1, 45 and 47(Notes 3)	$\pm 10$ mA
Input Current at Any Other Pin (Note 3)	$\pm 25$ mA
Package Input Current (Note 3)	$\pm 50$ mA
Power Dissipation at $T_A = 25^\circ C$	See (Note 4)
ESD Susceptibility (Note 5)	
Human Body Model	1500V
Machine Model	200V

Soldering Temperature, Infrared, 10 seconds (Note 6)	300°C
Storage Temperature	-65°C to +150°C

### Operating Ratings (Notes 1, 2)

Operating Temperature Range	-40°C $\leq T_A \leq$ +85°C
$V_A, V_D$	+4.75V to +5.25V
$DR V_D$	2.7V to $V_D$
$V_{REF}$	1.0V to 2.7V
Digital Inputs	-0.3V to $V_D + 0.3V$
Analog Inputs	-0.3V to $V_A + 0.3V$
$ V_A - V_D $	$\leq 100$ mV
$ AGND - DGND $	0V to 100 mV

### Converter Electrical Characteristics

The following specifications apply for  $AGND = DGND = DR GND = 0V, V_A = V_D = +5.0V_{DC}, DR V_D = 3.0V$  or  $5.0V, PD = 0V, V_{REF, IN} = +2.0V, V_{IN}$  (common mode) =  $1.0V, f_{CLK} = 7$  MHz @ 50% duty cycle,  $t_r, t_f = 4$  ns,  $C_L = 20$  pF/pin. **Boldface limits apply for  $T_A = T_J = T_{MIN}$  to  $T_{MAX}$ : all other limits  $T_A = T_J = 25^\circ C$**  (Notes 7, 8, 9)

Symbol	Parameter	Conditions	Typical (Note 10)	Limits (Note 11)	Units
<b>STATIC CONVERTER CHARACTERISTICS</b>					
	Resolution with No Missing Codes			<b>14</b>	Bits (min)
INL	Integral Non-Linearity (note 12)		$\pm 2.2$		LSB
DNL	Differential Non-Linearity		$\pm 0.6$	<b>+1.0</b> <b>-0.85</b>	LSB (max)
FSE	Positive and Negative Full-Scale Error	25°C	0.9	2.3	%FS
TC FSE	Full-Scale Error Tempco		-5		ppm/°C
ZSE	Zero Offset Error	25°C	0.1		%FS
TC ZSE	Zero Offset Error Tempco		-0.6		ppm/°C
<b>REFERENCE AND ANALOG INPUT CHARACTERISTICS</b>					
$V_{REF}$	Reference Voltage Range		2.00	<b>1.0</b> <b>2.7</b>	V(min) V(max)
$R_R$	Reference Input Resistance		10M		Ohms
$C_R$	Reference Input Capacitance		5		pF
$V_{IN}$	Input Voltage Range ( $V_{IN+} - V_{IN-}$ )	$V_{IN}$ (common Mode) = $V_{REF}/2$	$\pm 2.0$	<b><math>\pm 1.0</math></b> <b><math>\pm 2.7</math></b>	V(min) V(max)
$C_{IN}$	$V_{IN+}, V_{IN-}$ Input Capacitance	$V_{IN} = 1.0V + 0.7 V_{rms}$	(CLK LOW)	14	pF
			(CLK HIGH)	5	pF
<b>DYNAMIC CONVERTER CHARACTERISTICS</b>					
BW	Full Power Bandwidth	-1 dB	20		MHz
		-3 dB	25		MHz
ENOB	Effective Number of Bits	$f_{IN} = 500$ kHz	12.6	12.0	Bits (min)
		$f_{IN} = 3.5$ MHz	12.0		Bits
SINAD	Signal-to-Noise and Distortion	$f_{IN} = 500$ kHz	77	74	dB (min)
		$f_{IN} = 3.5$ MHz	74		dB
SNR	Signal -to-Noise Ratio (Note 13)	$f_{IN} = 500$ kHz	80	78	dB (min)
		$f_{IN} = 3.5$ MHz	77		dB
THD	Total Harmonic Distortion	$f_{IN} = 500$ kHz	-83	-76	dB (min)
		$f_{IN} = 3.5$ MHz	-79		dB

## Converter Electrical Characteristics (Continued)

The following specifications apply for AGND = DGND = DR GND = 0V,  $V_A = V_D = +5.0V_{DC}$ , DR  $V_D = 3.0V$  or  $5.0V$ , PD = 0V,  $V_{REF,IN} = +2.0V$ ,  $V_{IN}$  (common mode) = 1.0V,  $f_{CLK} = 7$  MHz @ 50% duty cycle,  $t_r, t_f = 4ns$ ,  $C_L = 20$  pF/pin. **Boldface limits apply for  $T_A = T_J = T_{MIN}$  to  $T_{MAX}$** ; all other limits  $T_A = T_J = 25^\circ C$  (Notes 7, 8, 9)

Symbol	Parameter	Conditions	Typical (Note 10)	Limits (Note 11)	Units
<b>DYNAMIC CONVERTER CHARACTERISTICS</b>					
SFDR	Spurious Free Dynamic Range	$f_{IN} = 500$ kHz	90		dB
		$f_{IN} = 3.5$ MHz	81		dB
IMD	Intermodulation Distortion	$f_{IN1} = 95$ kHz $f_{IN2} = 105$ kHz	-97		dB

## DC and Logic Electrical Characteristics

The following specifications apply for AGND = DGND = DR GND = 0V,  $V_A = V_D = +5.0V_{DC}$ , DR  $V_D = 3.0V$  or  $5.0V$ , PD = 0V,  $V_{REF,IN} = +2.0V$ ,  $V_{IN}$  (common mode) = 1.0V,  $f_{CLK} = 7$  MHz @ 50% duty cycle,  $t_r, t_f = 4ns$ ,  $C_L = 20$  pF/pin. **Boldface limits apply for  $T_A = T_J = T_{MIN}$  to  $T_{MAX}$** ; all other limits  $T_A = T_J = 25^\circ C$  (Notes 7, 8, 9)

Symbol	Parameter	Conditions	Typical (Note 10)	Limits (Note 11)	Units
<b>CLOCK OE, PD DIGITAL INPUT CHARACTERISTICS</b>					
$V_{IH}$	Logical "1" Input Voltage	$V^+ = 5.25V$		<b>2.0</b>	V(min)
$V_{IL}$	Logical "0" Input Voltage	$V^+ = 5.25V$		<b>0.8</b>	V(max)
$I_{IH}$	Logical "1" Input Current	$V_{IN} = 5.0V$	1		$\mu A$
$I_{IL}$	Logical "0" Input Current	$V_{IN} = 0V$	-1		$\mu A$
$C_{IN}$	$V_{IN}$ Input Capacitance		5		pF

### D00 – D13 DIGITAL OUTPUT CHARACTERISTICS

$V_{OH}$	Logical "1" Output Voltage	DR $V_D = 4.75V$ , $I_{OUT} = -360 \mu A$		<b>4.5</b>	V(min)
		DR $V_D = 2.7V$ , $I_{OUT} = -360 \mu A$		<b>2.5</b>	V(min)
$V_{OL}$	Logical "0" Output Voltage	DR $V_D = 4.75V$ , $I_{OUT} = 1.6$ mA		<b>0.4</b>	V(max)
		DR $V_D = 2.7V$ , $I_{OUT} = 1.6$ mA		<b>0.4</b>	V(max)
$I_{OZ}$	TRI-STATE Output Current	$V_{OUT} = 3V$ or $5V$	100		nA
		$V_{OUT} = 0V$	-100		nA
$+I_{SC}$	Output Short Circuit Source Current	DR $V_D = 3V$ , $V_{OUT} = 0V$	-10		mA
$-I_{SC}$	Output Short Circuit Sink Current	$V_{OUT} = DR V_D = 3V$	12		mA

### POWER SUPPLY CHARACTERISTICS

$I_A$	Analog Supply Current	PD = DGND	75.7	<b>81</b>	mA(max)
$I_D + I_{DR}$	Digital Supply Current	PD = DGND, no output load, dc input	0.3	<b>2</b>	mA(max)
	Total Power Consumption	PD = DGND, no output load, dc input	380	<b>425</b>	mW(max)
		PD = DR $V_D$ , no output load, dc input	20		mW
PSRR	Power Supply Rejection Ratio	Change in FS Error with 0.5V change in $V_A$	70		dB
		250 mV <sub>PP</sub> 100 kHz riding on $V_A$	46		dB

## AC Electrical Characteristics

The following specifications apply for AGND = DGND = DR GND = 0V,  $V_A = V_D = +5.0V_{DC}$ , DR  $V_D = 3.0V$  or  $5.0V$ , PD = 0V,  $V_{REF,IN} = +2.0V$ ,  $V_{IN}$  (common mode) = 1.0V,  $f_{CLK} = 7$  MHz @ 50% duty cycle,  $t_r, t_f = 4$  ns,  $C_L = 20$  pF/pin. **Boldface limits apply for  $T_A = T_J = T_{MIN}$  to  $T_{MAX}$** ; all other limits  $T_A = T_J = 25^\circ C$  (Notes 7, 8, 9)

Symbol	Parameter	Conditions	Typical (Note 10)	Limits (Note 11)	Units
$f_{CLK}$	Conversion Clock Frequency		25		kHz(min)
			8	<b>7</b>	MHz(max)
	Conversion Clock Duty Cycle		45		%(min)
			55		%(max)

## AC Electrical Characteristics (Continued)

The following specifications apply for AGND = DGND = DR GND = 0V,  $V_A = V_D = +5.0V_{DC}$ , DR  $V_D = 3.0V$  or  $5.0V$ , PD = 0V,  $V_{REF IN} = +2.0V$ ,  $V_{IN}$  (common mode) = 1.0V,  $f_{CLK} = 7$  MHz @ 50% duty cycle,  $t_r, t_f = 4$  ns,  $C_L = 20$  pF/pin. **Boldface limits apply for  $T_A = T_J = T_{MIN}$  to  $T_{MAX}$ ; all other limits  $T_A = T_J = 25^\circ C$  (Notes 7, 8, 9)**

Symbol	Parameter	Conditions	Typical (Note 10)	Limits (Note 11)	Units
$t_{CL}$	Conversion Clock Low Time		<b>63</b>		ns(min)
$t_{CH}$	Conversion Clock High Time		<b>63</b>		ns(min)
$t_{CONV}$	Conversion Latency		12		Clock Cycles
$t_{AD}$	Aperture Delay		3		ns
$t_{AJ}$	Aperture Jitter		5		ps(rms)
$t_{OD}$	Rising Edge of CLOCK to Data Valid	DR $V_D = 3.0V$	45	<b>58</b>	ns(max)
		DR $V_D = 5.0V$	34	<b>53</b>	ns(max)
$t_{EN}$	$\overline{OE}$ Low to Data Valid on D00 – D13		35		ns
$t_{DIS}$	$\overline{OE}$ High to D0 – D13 into TRI-STATE®		12		ns

**Note 1:** Absolute Maximum Ratings indicate limits beyond which damage to the device may occur. Operating Ratings indicate conditions for which the device is functional, but do not guarantee specific performance limits. For guaranteed specifications and test conditions, see the Electrical Characteristics. The guaranteed specifications apply only for the test conditions listed. Some performance characteristics may degrade when the device is not operated under the listed test conditions.

**Note 2:** All voltages are measured with respect to GND = AGND = DGND = DR GND = 0V, unless otherwise specified.

**Note 3:** When the input voltage at any pin exceeds the power supplies (that is,  $V_{IN} < AGND$  or  $V_{IN} > V_A$  or  $V_D$ ), the current at that pin should be limited to 25 mA (10 mA for pins 1, 45 and 47). The 50 mA maximum package input current rating limits the number of pins that can safely exceed the power supplies with an input current of 25 mA to two.

**Note 4:** The absolute maximum junction temperature ( $T_{Jmax}$ ) for this device is  $150^\circ C$ . The maximum allowable power dissipation is dictated by  $T_{Jmax}$ , the junction-to-ambient thermal resistance ( $\theta_{JA}$ ), and the ambient temperature ( $T_A$ ), and can be calculated using the formula  $P_{DMAX} = (T_{Jmax} - T_A)/\theta_{JA}$ . In the 48-pin TQFP,  $\theta_{JA}$  is  $76^\circ C/W$ , so  $P_{DMAX} = 1,345$  mW at  $25^\circ C$  and 855 mW at the maximum operating ambient temperature of  $85^\circ C$ . Note that the power dissipation of this device under normal operation will typically be about 400 mW (380 mW quiescent power +20 mW due to 1 TTL load on each digital output). The values for maximum power dissipation listed above will be reached only when the ADC14071 is operated in a severe fault condition (e.g. when input or output pins are driven beyond the power supply voltages, or the power supply polarity is reversed). Obviously, such conditions should always be avoided.

**Note 5:** Human body model is 100 pF capacitor discharged through a 1.5 kΩ resistor. Machine model is 220 pF discharged through ZERO ohms.

**Note 6:** See AN450, "Surface Mounting Methods and Their Effect on Product Reliability", or the section entitled "Surface Mount" found in any post 1986 National Semiconductor Linear Data Book, for other methods of soldering surface mount devices.

**Note 7:** The inputs are protected as shown below. Input voltage magnitudes up to 0.3V above  $V_A$  or to 0.3V below GND will not damage this device, provided current is limited per (Note 3). However, errors in the A/D conversion can occur if the input goes above ( $V_A - 2.0V$ ) or below GND by more than 300 mV. As an example, if  $V_A$  is  $4.75V_{DC}$ , the full-scale input voltage must be  $\leq 2.75V_{DC}$  or  $\geq -300$  mV to ensure accurate conversions.

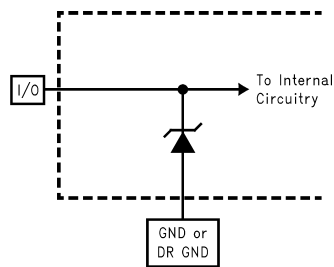

DS101101-8

### ESD Protection Scheme for Input and Output Pins

**Note 8:** To guarantee accuracy, it is required that  $V_A$  and  $V_D$  be connected together and to the same power supply with separate bypass capacitors at each  $V^+$  pin.

**Note 9:** With the test condition for  $V_{REF} = (V_{REF+} - V_{REF-})$  given as +2.0V, the 14-bit LSB is 244  $\mu V$ .

**Note 10:** Typical figures are at  $T_A = T_J = 25^\circ C$ , and represent most likely parametric norms.

**Note 11:** Tested limits are guaranteed to National's AOQL (Average Outgoing Quality Level).

**Note 12:** Integral Non-Linearity is defined as the deviation of the analog value, expressed in LSBs, from the straight line that passes through positive full-scale and negative full-scale.

**Note 13:** Optimum SNR performance will be obtained by keeping the reference input in the 1.8V to 2.7V range. The LM4041CIM3-ADJ (SOT-23 package) or the LM4041CIZ-ADJ (TO-92 package bandgap voltage reference is recommended for this application).

AC Electrical Characteristics (Continued)

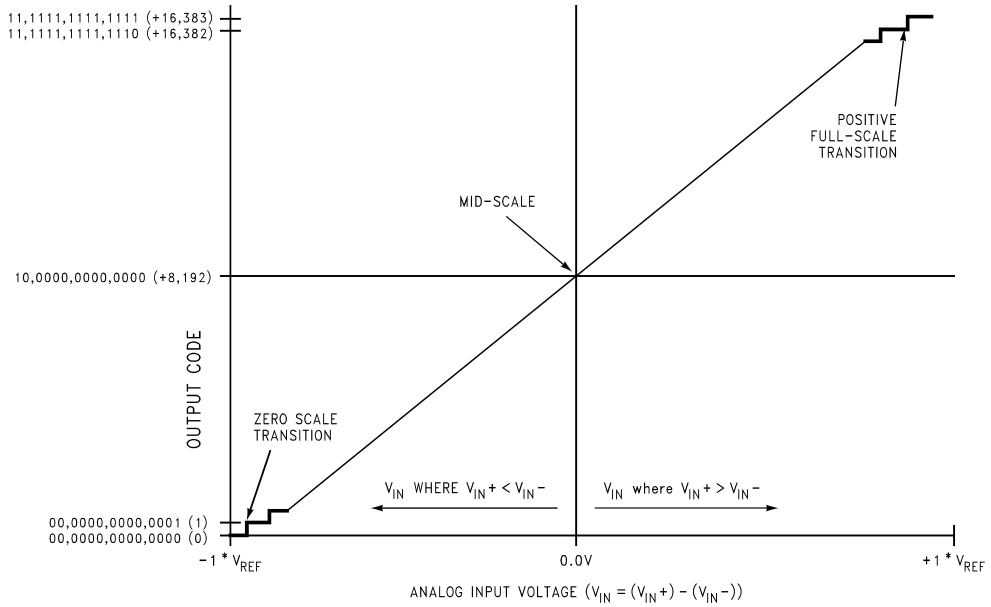

FIGURE 1. Transfer Characteristic

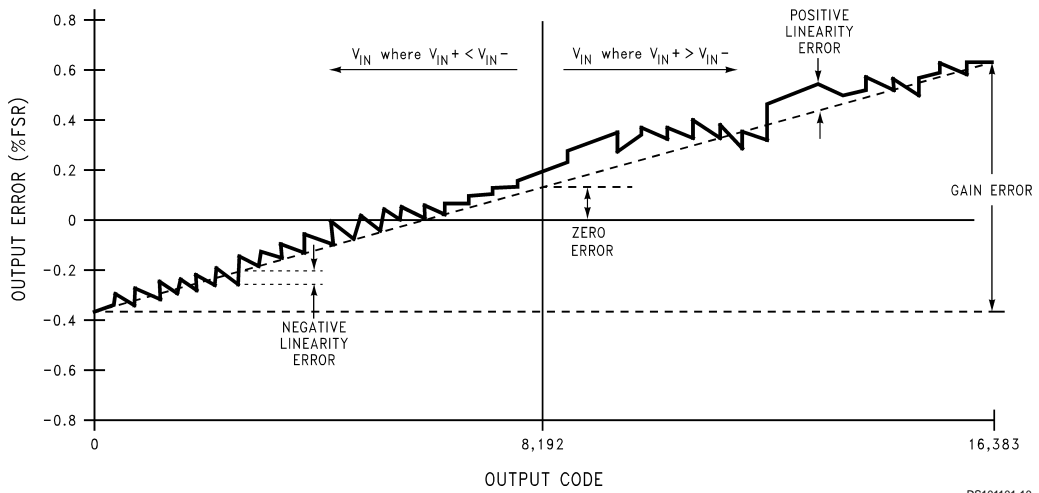
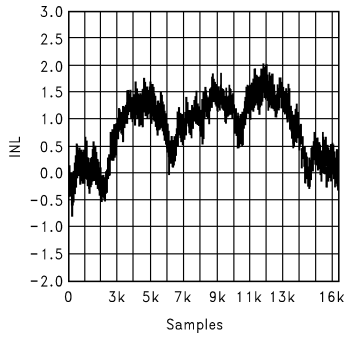

FIGURE 2. Description of Errors



**Typical Performance Characteristics**  $V_A = V_D = DR$   $V_D = 5V$ .  $f_{CLK} = 7MHz$ ,  $f_{IN} = 500KHz$  unless otherwise stated.

**INL**



DS101101-11

**DNL**

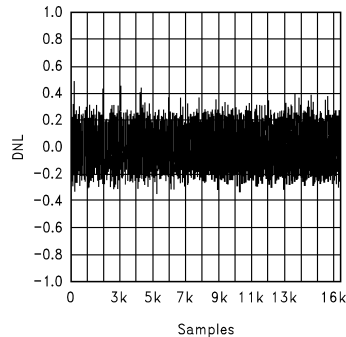

DS101101-12

**SNR vs Temperature**

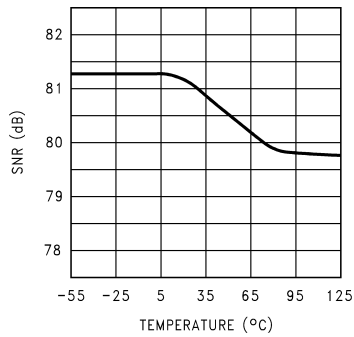

DS101101-13

**INL vs Temperature**

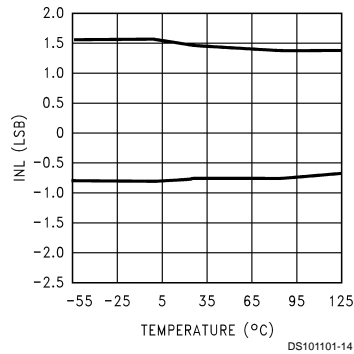

DS101101-14

**DNL vs Temperature**

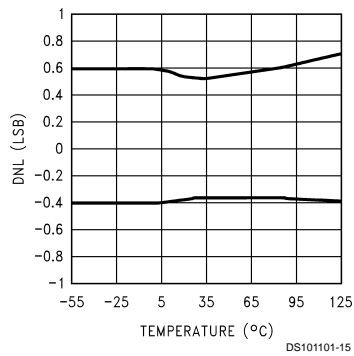

DS101101-15

**THD vs Temperature**

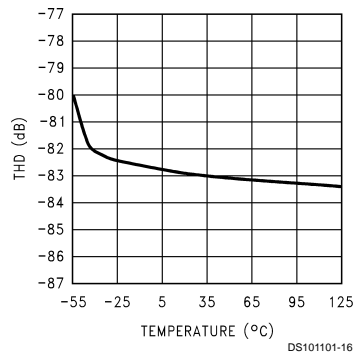

DS101101-16

**Typical Performance Characteristics**  $V_A = V_D = DR V_D = 5V$ ,  $f_{CLK} = 7MHz$ ,  $f_{IN} = 500KHz$  unless otherwise stated. (Continued)

**SINAD & ENOB vs Temp**

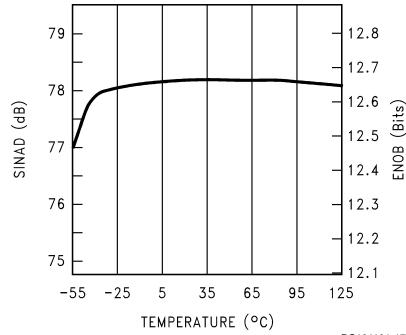

**SINAD & ENOB vs Clock Duty Cycle**

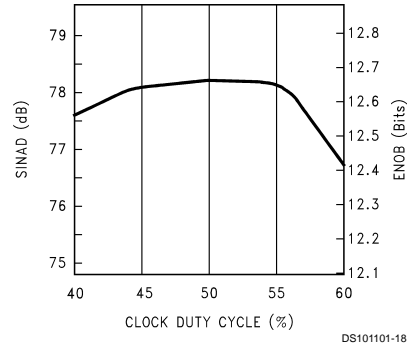

**SFDR vs Temperature**

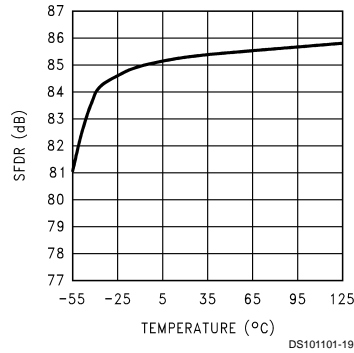

**Power Consumption vs  $f_{CLK}$**

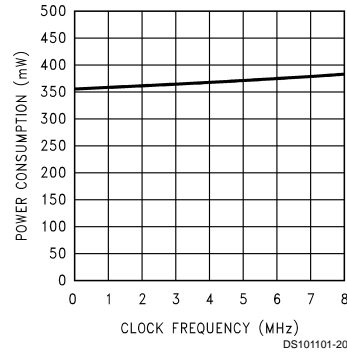

**IMD Response**

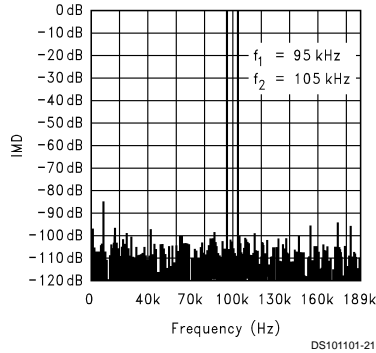

**Spectral Response**

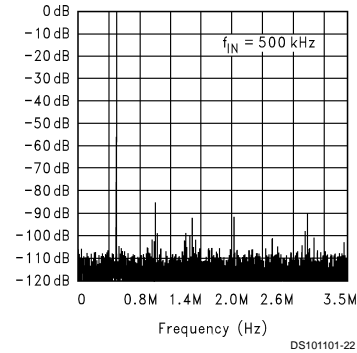

**Specification Definitions**

**APERTURE JITTER** is the variation in aperture delay from sample to sample. Aperture jitter shows up as input noise.

**APERTURE DELAY** is the time from the sampling edge of the clock to when the input signal is acquired or held for conversion. In other words, it is the time required for the Sample/ Hold circuit to go from the "sample" mode to the "hold"

mode. The Sample/ Hold circuit effectively stops capturing the input signal and goes into the "hold" mode this amount of time after the clock transition.

**DIFFERENTIAL NON-LINEARITY (DNL)** is the measure of the maximum deviation from the ideal step size of 1 LSB.

**EFFECTIVE NUMBER OF BITS (ENOB, or EFFECTIVE BITS)** is another method of specifying Signal-to-Noise and

## Specification Definitions (Continued)

**Distortion or SINAD.** ENOB is defined as  $(\text{SINAD} - 1.76)/6.02$  and says that the converter is equivalent to a perfect ADC of this (ENOB) number of bits.

**FULL POWER BANDWIDTH** is a measure of the frequency at which the reconstructed output fundamental drops 3 dB below its low frequency value for a full scale input. The test is performed with  $f_{\text{IN}}$  equal to 100 kHz plus integer multiples of  $f_{\text{CLK}}$ . The input frequency at which the output is -3 dB relative to the low frequency input signal is the full power bandwidth.

**INTERMODULATION DISTORTION (IMD)** is the creation of additional spectral components as a result of two sinusoidal frequencies being applied to the ADC input at the same time. It is defined as the ratio of the power in the intermodulation products to the total power in the original frequencies. IMD is usually expressed in dB.

**INTEGRAL NON-LINEARITY (INL)** is a measure of the deviation of each individual code from a line drawn from negative full scale ( $1/2$  LSB below the first code transition) through positive full scale (the last code transition). The deviation of any given code from this straight line is measured from the center of that code value.

**NEGATIVE FULL SCALE ERROR** is the measure of how far the last code transition is from the ideal of  $1/2$ LSB above nominal negative full scale. It is the difference between the input voltage ( $V_{\text{IN}^+} - V_{\text{IN}^-}$ ) just causing a transition to the first code and the ideal voltage to cause that transition. The ideal LSB transition (when it should occur) is  $(V_{\text{IN}^+} - V_{\text{IN}^-}) = 1/2$ LSB

**OFFSET ERROR** is the difference between the ideal and actual voltages that cause a transition to mid-scale (a code of 8192) when approached from a lower code. The ideal LSB transition (when it should occur) is  $(V_{\text{IN}^+} - V_{\text{IN}^-}) = 0$

**PIPELINE DELAY (LATENCY)** is the number of clock cycles between initiation of conversion and the availability of that same conversion result at the output. New data is available at every clock cycle, but the data lags the conversion by the pipeline delay.

**POSITIVE FULL SCALE ERROR** is a measure of how far the last code transition is from the ideal of  $1/2$ LSB below nominal positive full scale. It is the difference between the input voltage ( $V_{\text{IN}^+} - V_{\text{IN}^-}$ ) just causing a transition to positive full scale and  $V_{\text{REF}} - 1/2$ LSB. Full Scale Error is sometimes called Full Scale Offset Error.

**SIGNAL TO NOISE RATIO (SNR)** is the ratio, expressed in dB, of the rms value of the input signal to the rms value of the sum of all other spectral components below one-half the sampling frequency, not including harmonics or dc.

**SIGNAL TO NOISE PLUS DISTORTION (S/N+D or SINAD)** is the ratio, expressed in dB, of the rms value of the input signal to the rms value of all of the other spectral components below half the clock frequency, including harmonics but excluding dc.

**SPURIOUS FREE DYNAMIC RANGE (SFDR)** is the difference, expressed in dB, between the rms values of the input signal and the peak spurious signal, where a spurious signal is any signal present in the output spectrum that is not present at the input.

**TOTAL HARMONIC DISTORTION (THD)** is the ratio, expressed in dB or dBc, of the rms total of the first nine harmonic components to the rms value of the input signal.

## Timing Diagram

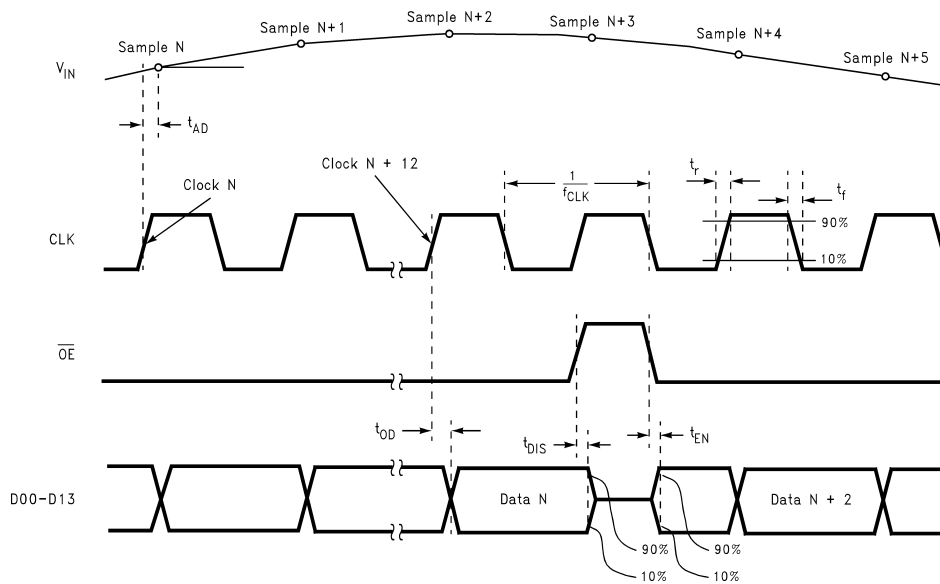

Output Timing

DS101101-23

## Functional Description

Operating on a single +5V supply, the ADC14071 uses a pipelined architecture and has error correction circuitry to help ensure maximum performance.

Balanced analog signals are digitized to 14 bits. Each of these input signals should have a peak-to-peak voltage equal to the input reference voltage,  $V_{REF}$ , and can be centered around  $V_{REF}/2$ . Table 1 and Table 2 indicate the input to output relationship of the ADC14071. As indicated in Table 2, biasing one input to  $V_{REF}/2$  and driving the other input with its full range signal results in a 6 dB reduction of the output range, limiting it to the range of  $1/4$  to  $3/4$  of the minimum output range obtainable if both inputs were driven with complementary signals.

Section 1.3 SIGNAL INPUTS explains how to avoid this signal reduction.

**TABLE 1. Input to Output Relationship— Differential Input**

$V_{IN+}$	$V_{IN-}$	Output
0	$V_{REF}$	00 0000 0000 0000
$0.25 \cdot V_{REF}$	$0.75 \cdot V_{REF}$	01 0000 0000 0000
$0.50 \cdot V_{REF}$	$0.50 \cdot V_{REF}$	10 0000 0000 0000
$0.75 \cdot V_{REF}$	$0.25 \cdot V_{REF}$	11 0000 0000 0000
$V_{REF}$	0	11 1111 1111 1111

**TABLE 2. Input to Output Relationship— Single-Ended Input**

$V_{IN+}$	$V_{IN-}$	Output
0	$V_{REF}/2$	01 0000 0000 0000
$0.25 \cdot V_{REF}$	$V_{REF}/2$	01 1000 0000 0000
$0.50 \cdot V_{REF}$	$V_{REF}/2$	10 0000 0000 0000
$0.75 \cdot V_{REF}$	$V_{REF}/2$	10 1000 0000 0000
$V_{REF}$	$V_{REF}/2$	11 0000 0000 0000

The output word rate is the same as the clock frequency, which can be between 25kSPS and 8 MSPS (typical). The analog input voltage is acquired at the rising edge of the clock and the digital data for that sample is delayed by the pipeline for 12 clock cycles.

A logic high on the power down (PD) pin reduces the converter power consumption to 20 mW.

## Applications Information

### 1.0 OPERATING CONDITIONS

We recommend that the following conditions be observed for operation of the ADC14071:

- $4.75V \leq V_A \leq 5.25V$
- $V_D = V_A$
- $2.7 \leq DR \cdot V_D \leq V_D$
- $25 \text{ kHz} \leq f_{CLK} \leq 8 \text{ MHz}$
- $1.0V \leq V_{REF} \leq 2.7V$

### 1.1 ANALOG INPUTS

The ADC14071 has two analog signal inputs,  $V_{IN+}$  and  $V_{IN-}$ . These two pins form a differential input. There is one reference input pin,  $V_{REF}$ .

### 1.2 REFERENCE INPUT

The ADC14071 is designed to operate with a 2.0V reference, but performs well with reference voltages in the range of 1.0V to 2.7V. Reducing the reference voltage below 1.0V will decrease the signal-to-noise ratio (SNR) of the ADC14071. Increasing the reference voltage (and the input signal swing) beyond 2.7V will degrade THD.

It is very important that all grounds associated with the reference voltage and the input signal make connection to the analog ground plane at a single point to minimize the effects of noise currents in the ground path.

The reference bypass pins ( $V_{REF+}$  BY,  $V_{REF-}$  BY and  $V_{REF}$  and  $V_{REF (MID)}$  BY) are for bypass purposes only. Bypass each of these pins to AGND with 0.1 $\mu$ F capacitors. DO NOT LOAD these pins.

### 1.3 SIGNAL INPUTS

The signal inputs are  $V_{IN+}$  and  $V_{IN-}$ . The input signal,  $V_{IN}$ , is defined as

$$V_{IN} = (V_{IN+}) - (V_{IN-}).$$

Figure 3 shows the expected input signal range.

Note that the nominal input common mode voltage is 1.0V. This assumes that the input signals run between the limits of AGND and 2V with  $V_{REF} = 2.0V$ . As the input signal  $V_{IN}$  increases above 4  $V_{P-P}$ , the input common mode range should become  $V_{REF}/2$ . The Peaks of the input signals should never exceed the voltage described as

$$\text{Peak Input Voltage} = V_A - 2.0V$$

to maintain signal integrity and THD and SINAD performance.

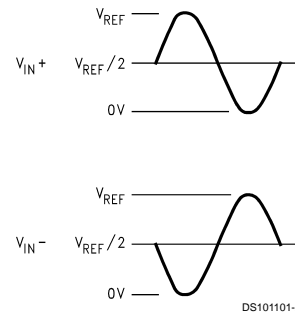

**FIGURE 3. Expected Input Signal Range**

The ADC14071 performs best with a differential input centered around half the reference voltage,  $V_{REF}$ . The peak-to-peak voltage swing at both  $V_{IN+}$  and  $V_{IN-}$  should not exceed the value of the reference voltage or the output data will be clipped. The two input signals should be exactly 180° out of phase from each other and of the same amplitude to avoid a reduction in the output amplitude. For angular deviations of up to 10° from these two signals being 180° out of phase, the full scale error in LSB can be described as

$$E_{FS} = \text{dev}^{1.79}$$

Where dev is the angular difference between the two signals having a 180° relative phase relationship to each other, as shown in Figure 4. Drive the analog inputs with a source impedance less than 100 $\Omega$ .

## Applications Information (Continued)

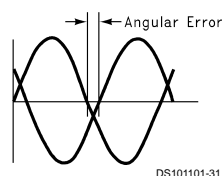

**FIGURE 4. Angular Errors between the Two Input Signals Will Reduce the Output Level**

For single ended operation, one of the analog inputs should be connected to a voltage equal to the reference voltage, with the common mode voltage of the driven input equal to that same voltage. The peak-to-peak input signal should be twice the reference voltage to minimize SNR and SINAD loss. For example, set the  $V_{REF}$  to 1.0V, bias  $V_{IN-}$  to 1.0V and drive  $V_{IN+}$  with signal range of 0V to 2.0V.

The  $V_{IN+}$  and the  $V_{IN-}$  inputs of the ADC14071 consist of an analog switch followed by a switched-capacitor amplifier. The capacitance seen at the analog input pins changes with the clock level, appearing as 14 pF when the clock is low, and 5 pF when the clock is high. Since a dynamic capacitance is more difficult to drive than is a fixed capacitance, choose the driving amplifier carefully. The LM6172 is a good amplifier for driving the ADC14071.

The internal switching action at the analog inputs causes energy to be output from the input pins. As the driving source tries to compensate for this, it adds noise to the signal. To prevent this, use 33 $\Omega$  series resistors at each of the signal inputs with a 0.0022  $\mu$ F capacitor across the inputs, as can be seen in Figures 6, 7. These components should be placed close to the ADC as the input pins of the ADC is the most sensitive part of the system and this is the last opportunity to filter the input.

### 2.0 DIGITAL INPUTS

Digital inputs consist of CLOCK,  $\overline{OE}$  and PD.

#### 2.1 CLOCK

The **CLOCK** signal controls the timing of the sampling process. Drive the clock input with a stable, low phase jitter clock signal in the range of 25 kHz to 8 MHz and rise and fall times of less than 4 ns. The trace carrying the clock signal should be as short as possible. This trace should not cross any other signal line, analog or digital, not even at 90°.

The **CLOCK** signal also drives the internal state machine. If the clock is interrupted, the charge on internal capacitors can dissipate to the point where the output data will lose accuracy.

The **CLOCK** pin should be terminated with a series 100 $\Omega$  resistor and 200 pF capacitor to ground located within two centimeters of the ADC14071 clock pin, as shown in Figure 5.

Whenever the trace between the clock source and the ADC clock pin is greater than 2 cm, use a 50 $\Omega$  series resistor in the clock line, located within 2 cm of the driving source.

#### 2.2 $\overline{OE}$

The  $\overline{OE}$  pin, when low, puts the output pins into a high impedance state. Be very careful when driving a high capacitance bus. The more capacitance the output drivers must charge for each conversion, the more instantaneous digital current flows through DR  $V_D$  and DR GND. These large charging current spikes can couple into the analog circuitry, degrading dynamic performance. Adequate bypassing and maintaining separate analog and digital ground planes will reduce this problem.

Additionally, bus capacitance beyond the specified 20 pF/pin will cause  $t_{OD}$  to increase, making it difficult to properly latch the ADC output data. The result could, again, be an apparent reduction in dynamic performance.

The digital data outputs should be buffered (with 74ACQ541, for example). Dynamic performance can also be improved by adding series resistors at each digital output, close to the ADC14071, which reduces the energy coupled back into the converter output pins by limiting the output current. A reasonable value for these resistors is 47 $\Omega$ .

#### 2.3 PD

The **PD** pin, when high, holds the ADC14071 in a power-down mode to conserve power when the converter is not being used. In this state the power consumption is 20 mW. The output data pins may change randomly when the PD pin is high. Power consumption during power-down is not affected by the clock frequency, or by whether there is a clock signal present. The data in the pipeline is corrupted while in the power down mode.

### 3.0 OUTPUTS

The ADC14071 has 15 digital outputs: 14 Data Output pins and OR (Out of Range).

The output pins are TTL/CMOS compatible and the output data format is straight binary. Valid data is present at these outputs while the  $\overline{OE}$  pin is low. While the  $t_{OD}$  time provides information about output timing, a simple way to capture a valid output is to latch the data on the *falling edge* of the conversion clock (pin 11).

To minimize noise due to output switching, minimize the load currents at the digital outputs. This can be done by connecting buffers between the ADC outputs and any other circuitry. Only one input should be connected to each output pin. Additionally, inserting series resistors of 47 $\Omega$  to 56 $\Omega$  at the digital outputs, close to the ADC pins, will isolate the outputs from trace and other circuitry capacitances and limit the output currents which could otherwise result in performance degradation, as discussed in Section 2.2. See Figure 5.

The OR pin indicates when the input signal is under- or over-range. This pin and the MSB, used together, will indicate whether the input is out of range low or high.



## Applications Information (Continued)

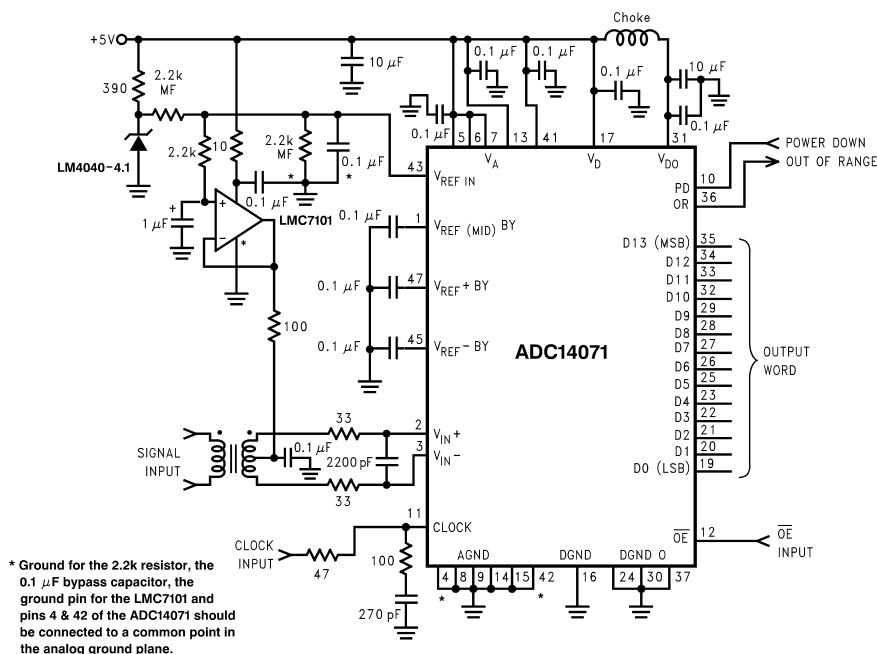

FIGURE 7. Driving the Signal Inputs with a Transformer

## 4.0 POWER SUPPLY CONSIDERATIONS

The power supply pin should be bypassed with a 10  $\mu$ F capacitor and with a 0.1  $\mu$ F ceramic chip capacitor a centimeter of each power pin. Leadless chip capacitors are preferred because they provide low lead inductance.

As is the case with all high-speed converters, the ADC14071 is sensitive to power supply noise. Accordingly the noise on the analog supply pin should be kept below 10 mV<sub>p-p</sub>.

No pin should ever have a voltage on it that is in excess of the supply voltages, not even on a transient basis. Be especially careful of this during power up.

The DR  $V_D$  pin provides power for the output drivers and may be operated from a supply in the range of 2.7V to the  $V_D$  supply (nominal 5V). This can simplify interfacing to 3.0V devices and systems. Powering the DR  $V_D$  from 3V will also reduce power consumption and noise generation due to output switching. **DO NOT operate the DR  $V_D$  pin at a voltage higher than  $V_D$ .**

## 5.0 LAYOUT AND GROUNDING

Proper grounding and proper routing of all signals are essential to ensure accurate conversion. Separate analog and digital ground planes that are connected close to the ADC14071 are required to achieve specified performance. The analog and digital grounds may be in the same layer, but should be separated from each other and should never overlap each other. Separation should be at least 1/8 inch (3 mm), where possible.

The ground return for the data outputs (DR GND) carries the ground current for the output drivers. The output current can exhibit high transients that could add noise to the conversion

process. To prevent this from happening, the DR GND pins should not be connected to system ground in close proximity to any of the ADC14071's other ground pins.

Capacitive coupling between the typically noisy digital ground plane and the sensitive analog circuitry can lead to poor performance. The solution is to keep the analog circuitry separated from the digital circuitry and from the digital ground plane, as well as to keep the clock line as short as possible.

Digital circuits create substantial supply and ground current transients. The logic noise thus generated could have significant impact upon system noise performance. The best logic family to use in systems with A/D converters is one which employs non-saturating transistor designs, or has low noise characteristics, such as the 74LS, 74HC(T) and 74AC(T)Q families. The worst noise generators are logic families that draw the largest supply current transients during clock or signal edges, like the 74F and the 74AC(T) families.

Since digital switching transients are composed largely of high frequency components, total ground plane copper weight will have little effect upon the logic-generated noise. This is because of the skin effect. Total surface area is more important than is total ground plane volume.

An effective way to control ground noise is by connecting the analog and digital ground planes together beneath the ADC with a copper trace that is very narrow compared with the rest of the ground plane. A typical width is about 1/16 inch (1.5 mm to 2 mm) but will depend upon the total analog ground current that will flow through it. This narrowing provides a fairly high impedance to the high edge rates of the digital switching currents, directing them away from the analog pins. The lower slew rate analog ground currents see a

## Applications Information (Continued)

relatively low impedance across this narrow ground connection. This implies that the power supply ground should be connected to the digital ground plane.

Generally, analog and digital lines should cross each other at 90° to avoid crosstalk. To maximize accuracy in high speed, high resolution systems, however, avoid crossing analog and digital lines altogether. It is important to keep any clock line as short as possible and isolated from ALL other lines, including other digital lines. Even the generally accepted 90° crossing should be avoided as even a little coupling can cause problems at high frequencies. This is because other lines can introduce phase noise (jitter) into the clock line, which can lead to degradation of SNR. Also, the high speed clock can introduce noise into the analog chain.

Best performance at high frequencies and at high resolution is obtained with a straight signal path. That is, the signal path through all components should form a straight line wherever possible.

Be especially careful with the layout of inductors. Mutual inductance can change the characteristics of the circuit in

which they are used. Inductors should *not* be placed side by side, even with just a small part of their bodies beside each other.

The analog input should be isolated from noisy signal traces to avoid coupling of spurious signals into the input. Any external component (e.g., a filter capacitor) connected between the converter's input pins and ground or to the reference pin and ground should be connected to a very clean point in the analog ground plane.

Figure 8 gives an example of a suitable layout. All analog circuitry (input amplifiers, filters, reference components, etc.) should be placed over the analog ground plane. All digital circuitry and I/O lines should be placed over the digital ground plane. Furthermore, all components in the reference circuitry and the input signal chain that are connected to ground should be connected together with traces and enter the analog ground plane at a single point.

All ground connections should have a low inductance path to ground.

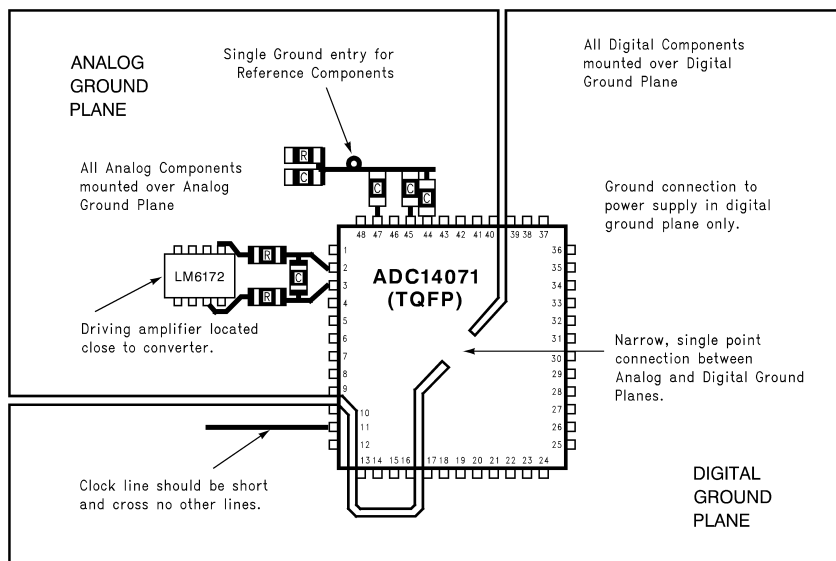

DS101101-28

FIGURE 8. Example of A Suitable Layout

### 6.0 DYNAMIC PERFORMANCE

To achieve the best dynamic performance with the ADC14071, the clock source driving the CLK input must be free of jitter. For best ac performance, isolate the ADC clock from any digital circuitry with buffers, as with the clock tree shown in Figure 9.

As mentioned in Section 5.0, it is good practice to keep the ADC clock line as short as possible and to keep it well away from any other signals. Other signals can introduce phase noise (jitter) into the clock signal, which can lead to reduced SNR performance, and the clock can introduce noise into other lines. Even lines with 90° crossings have capacitive coupling, so try to avoid even these 90° crossings of the clock line.



## Applications Information (Continued)

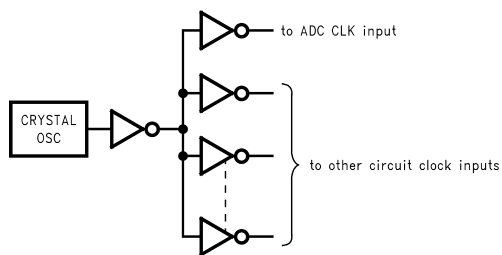

DS101101-29

**FIGURE 9. Isolating the ADC Clock from other Circuitry with A Clock Tree**

### 7.0 COMMON APPLICATION PITFALLS

**Driving the inputs (analog or digital) beyond the power supply rails.** For proper operation, all inputs should not go more than 300 mV beyond the supply rails (more than 300 mV below the ground pins or 300 mV above the supply pins). Exceeding these limits on even a transient basis may cause faulty or erratic operation. It is not uncommon for high speed digital circuits (e.g., 74F and 74AC devices) to exhibit overshoot or undershoot that goes above the power supply or more than a volt below ground. A resistor of about 50Ω to 100Ω in series with the offending digital input will eliminate the problem.

Do not allow input voltages to exceed the supply voltage, even on a transient basis. Not even during power up.

Be careful not to overdrive the inputs of the ADC14071 with a device that is powered from supplies outside the range of the ADC14071 supply. Such practice may lead to conversion inaccuracies and even to device damage.

**Attempting to drive a high capacitance digital data bus.** The more capacitance the output drivers must charge for each conversion, the more instantaneous digital current flows through DR V<sub>D</sub> and DR GND. These large charging current spikes can couple into the analog circuitry, degrading dynamic performance. Adequate bypassing and maintaining separate analog and digital ground planes will reduce this problem.

Additionally, bus capacitance beyond the specified 20 pF/pin will cause t<sub>OD</sub> to increase, making it difficult to properly latch the ADC output data. The result could, again, be an apparent reduction in dynamic performance.

The digital data outputs should be buffered (with 74ACQ541, for example). Dynamic performance can also be improved by adding series resistors at each digital output, close to the ADC14071, which reduces the energy coupled back into the converter output pins by limiting the output current. A reasonable value for these resistors is 47Ω.

**Using an inadequate amplifier to drive the analog input.** As explained in Section 1.3, the capacitance seen at the input alternates between 14 pF and 5 pF, depending upon the phase of the clock. This dynamic load is more difficult to drive than is a fixed capacitance.

If the amplifier exhibits overshoot, ringing, or any evidence of instability, even at a very low level, it will degrade performance. A small series resistor at each amplifier output and a capacitor across the analog inputs (as shown in Figures 6, 7) will improve performance. The LM6172 has been successfully used to drive the analog inputs of the ADC14071.

Also, it is important that the signals at the two inputs have exactly the same amplitude and be exactly 180° out of phase with each other. Board layout, especially equality of the length of the two traces to the input pins, will affect the effective phase between these two signals. Remember that an operational amplifier operated in the non-inverting configuration will exhibit more time delay than will the same device operating in the inverting configuration.

**Operating with the reference pins outside of the specified range.** As mentioned in Section 1.2, V<sub>REF</sub> should be in the range of

$$1.0V \leq V_{REF} \leq 2.7V.$$

Operating outside of these limits could lead to performance degradation.

**Using a clock source with excessive jitter, using excessively long clock signal trace, or having other signals coupled to the clock signal trace.** This will cause the sampling interval to vary, causing excessive output noise and a reduction in SNR performance.

**Physical Dimensions** inches (millimeters) unless otherwise noted

METRIC ONLY

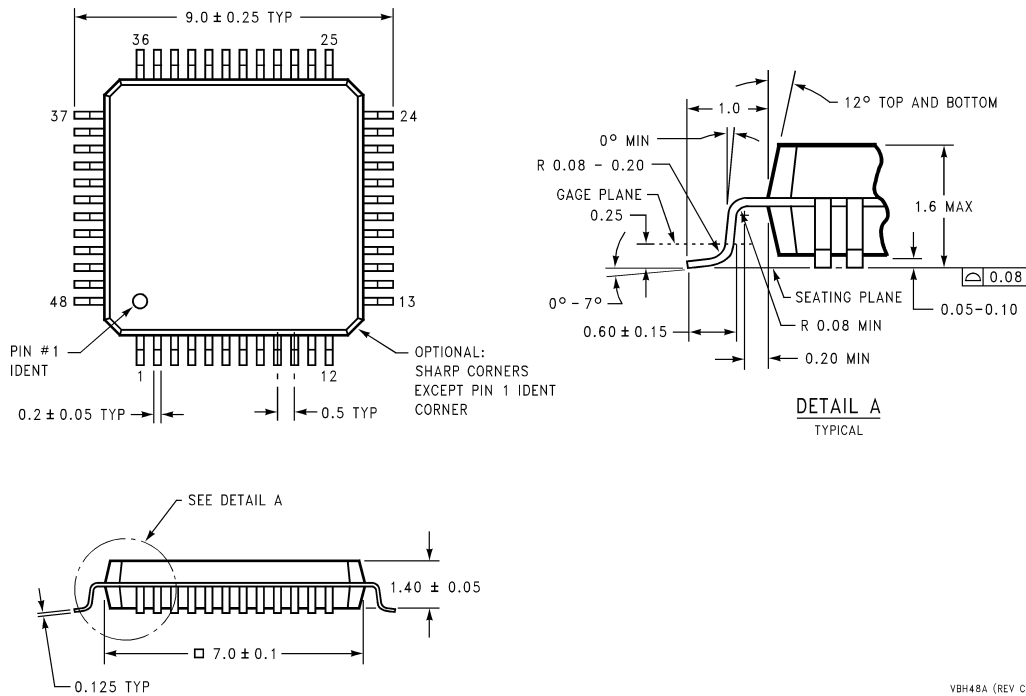

**48-Lead TQFP Package**  
**Order Number ADC14071CIVBH**  
**NS Package Number VBH48A**

VBH48A (REV C)

**LIFE SUPPORT POLICY**

NATIONAL'S PRODUCTS ARE NOT AUTHORIZED FOR USE AS CRITICAL COMPONENTS IN LIFE SUPPORT DEVICES OR SYSTEMS WITHOUT THE EXPRESS WRITTEN APPROVAL OF THE PRESIDENT AND GENERAL COUNSEL OF NATIONAL SEMICONDUCTOR CORPORATION. As used herein:

1. Life support devices or systems are devices or systems which, (a) are intended for surgical implant into the body, or (b) support or sustain life, and whose failure to perform when properly used in accordance with instructions for use provided in the labeling, can be reasonably expected to result in a significant injury to the user.
2. A critical component is any component of a life support device or system whose failure to perform can be reasonably expected to cause the failure of the life support device or system, or to affect its safety or effectiveness.



**National Semiconductor Corporation**  
 Americas  
 Tel: 1-800-272-9959  
 Fax: 1-800-737-7018  
 Email: support@nsc.com

www.national.com

**National Semiconductor Europe**  
 Fax: +49 (0) 1 80-530 85 86  
 Email: europe.support@nsc.com  
 Deutsch Tel: +49 (0) 1 80-530 85 85  
 English Tel: +49 (0) 1 80-532 78 32  
 Français Tel: +49 (0) 1 80-532 93 58  
 Italiano Tel: +49 (0) 1 80-534 16 80

**National Semiconductor Asia Pacific Customer Response Group**  
 Tel: 65-2544466  
 Fax: 65-2504466  
 Email: sea.support@nsc.com

**National Semiconductor Japan Ltd.**  
 Tel: 81-3-5639-7560  
 Fax: 81-3-5639-7507